

Heavy Duty Product Specification Zinc Flake 1000Hr SSP (1000 hour Salt Spray Protection)

Product Code	Bolt Size	Hole Diameter	Clamping Range		Depth Clearance	Corrosion Protection Salt Spray (hours)
			Min	Max		
HD0845ZF	M8 x 45	8	7	25	10	Zinc Flake 1000Hr
HD1045ZF	M10 x 45	10	7	25	12	Zinc Flake 1000Hr
HD1060ZF	M10 x 60	10	7	40	12	Zinc Flake 1000Hr
HD1245ZF	M12 x 45	12	8	22	15	Zinc Flake 1000Hr
HD1260ZF	M12 x 60	12	8	34	15	Zinc Flake 1000Hr
HD1275ZF	M12 x 75	12	8	48	15	Zinc Flake 1000Hr
HD1660ZF	M16 x 60	16	12	30	25	Zinc Flake 1000Hr
HD1675ZF	M16 x 75	16	12	45	25	Zinc Flake 1000Hr
HD2070ZF	M20 x 70	20	15	32	30	Zinc Flake 1000Hr
HD2085ZF	M20 x 85	20	15	47	30	Zinc Flake 1000Hr

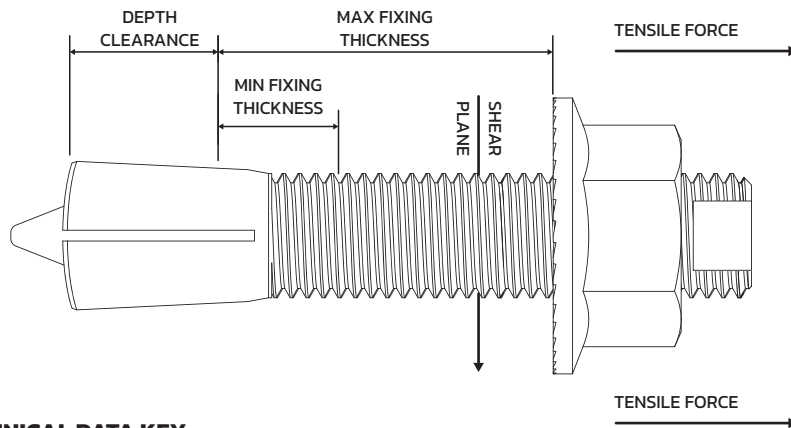

TECHNICAL DATA KEY

Design Resistances for HD Type Blind Bolts. Design to BS EN 1993-1-8 Zinc Flake 1000Hr SSP HD BOLTS

Bolt Size	Tensile (kN)	Single Shear (kN)	Recommended Pre-load Tightening Torque (Nm)
M8	8.5	14.1	20
M10	25.2	22.3	35
M12	46.4	32.3	45
M16	57.5	60.1	95
M20	77.5	94.1	120

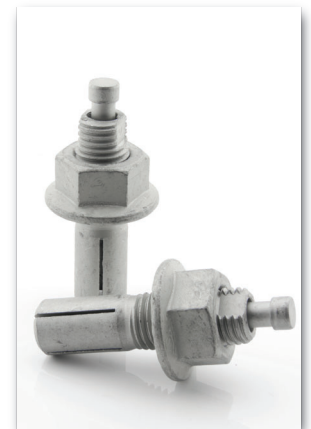

The Above Resistances are equally appropriate for designs to BS 5950.

Designers are reminded that the strength and deformation of the support must be checked in thin plate as this may be critical.



Heavy Duty Product Specification A4-70 STAINLESS STEEL

Product Code	Bolt Size	Hole Diameter	Clamping Range		Depth Clearance
			Min	Max	
HD0845SS	M8 x 45	8	7	25	10
HD1045SS	M10 x 45	10	7	25	12
HD1060SS	M10 x 60	10	7	40	12
HD1245SS	M12 x 45	12	8	22	15
HD1260SS	M12 x 60	12	8	37	15
HD1660SS	M16 x 60	16	12	30	25
HD2070SS	M20 x 70	20	15	32	30

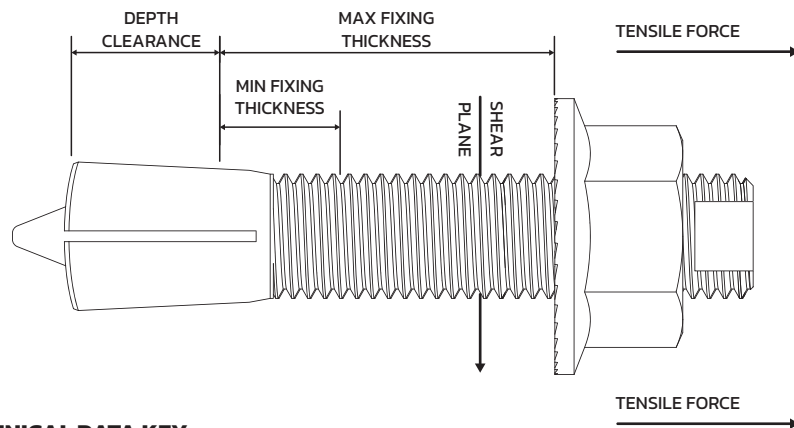

TECHNICAL DATA KEY

Design Resistances for HD Type Blind Bolts Design to BS EN 1993-1-8 A4-70 STAINLESS STEEL

Bolt Size	Tensile (kN)	Shear (kN)	Recommended Pre-load Tightening Torque (Nm)
M8	10.5	12.9	18
M10	20.2	20.0	24
M12	31.4	29.5	30
M16	40.1	41.5	45
M20	68.7	75.2	80



The Above Resistances are equally appropriate for designs to BS 5950.

Designers are reminded that the strength and deformation of the support must be checked in thin plate as this may be critical.